

La nuovissima idea che lascia libera la fantasia del progettista. Un sistema dalle molteplici soluzioni: per rivestire, per dividere, per decorare, per attrezzare, per realizzare dei box chiusi all'interno di una stanza. Il sistema è caratterizzato da una struttura portante e da pannelli decorativi che possono essere fissati ad essa in maniera semplice tramite calamite cosicché da rendere i pannelli decorativi facili da rimuovere, da sostituire e da rimodulare. I campi di utilizzo sono molteplici per gli interni: per la casa, per l'hotel, per il negozio e per l'ufficio, molteplici funzioni ed infinite aree di gusto.

The brand-new concept that gives free rein to the designer's imagination. A system made up of multiple solutions: to cover, divide, decorate, equip and create closed boxes inside a room. The system is comprised of a supporting structure and decorative panels secured through the simple use of magnets, making them easy to remove, easy to replace, and easy to reconfigure.

The range of indoor applications are endless: the home, hotels, retail stores and the office, offering countless functions and infinite styles.

La toute nouvelle idée qui laisse libre cours à l'imagination du concepteur. Un système aux solutions multiples : habiller, diviser, décorer, équiper, créer des espaces fermés à l'intérieur d'une pièce. Le système se caractérise par une structure porteuse et des panneaux décoratifs qui s'y fixent facilement à l'aide d'aimants, de sorte que les panneaux décoratifs sont faciles à enlever, faciles à remplacer, faciles à composer. Les domaines d'utilisation sont multiples pour les intérieurs : maison, hôtel, magasin et bureau, des fonctions multiples et des zones de goût infinies.

Die brandneue Idee, die der Fantasie des Planers freien Lauf lässt. Ein System mit einer Vielzahl von Lösungen: zum Verkleiden, zum Teilen, zum Dekorieren, zum Ausrüsten und um geschlossene Boxen in einem Raum zu schaffen. Das System zeichnet sich durch eine tragende Struktur und Dekorpaneele aus, die einfach mit Magneten daran befestigt werden können, sodass die Dekorpaneele leicht zu entfernen, auszutauschen und neuzugestalten sind. Die Einsatzmöglichkeiten für Innenräume sind vielfältig: für zu Hause, für das Hotel, für das Geschäft und für das Büro, unzählige Funktionen und unendliche Geschmacksrichtungen.

La idea más reciente que libera la imaginación del diseñador. Un sistema con múltiples soluciones: revestir, dividir, decorar, equipar, crear box cerrados dentro de una habitación. El sistema se caracteriza por una estructura portante y paneles decorativos que pueden fijarse fácilmente a ella mediante imanes, de modo que los paneles decorativos son fáciles de retirar, sustituir y remodelar. Los campos de uso son múltiples para los interiores: para el hogar, los hoteles, las tiendas y las oficinas, múltiples funciones e infinitas áreas de aplicación.



pure cladding





Chameleon risponde all'esigenza di schermare e decorare lo sbarco ascensori che molto spesso affaccia direttamente nell'area uffici, il prodotto è personalizzabile con la propria brand image e adattabile agli spazi e alle esigenze estetiche.

Chameleon is perfect for shielding or decorating elevator landing areas, which often directly overlook the office space. The product can be customised with the company's brand and adapted to the space and style needs.

Chameleon répond à la nécessité de masquer et de décorer le palier de l'ascenseur, qui donne très souvent directement sur la zone des bureaux. Le produit peut être personnalisé avec sa propre image de marque et s'adapter aux exigences d'espace et d'esthétique.

Chameleon reagiert auf die Notwendigkeit, den Ausstiegsbereich von Aufzügen abzuschirmen und zu dekorieren, der oft direkt auf den Bürobereich blickt. Das Produkt kann mit Ihrem eigenen Markenimage individuell gestaltet und an Räume und ästhetische Bedürfnisse angepasst werden.

Chameleon responde a la necesidad de apantallar y decorar el rellano del ascensor, que muy a menudo da directamente a la zona de oficinas, el producto puede personalizarse con su propia imagen de marca y adaptarse al espacio y a los requisitos estéticos.





tipologia: a parete con pannello da un lato
typology: wall mounted with panel on one side

A.
particolare a soffitto
ceiling detail

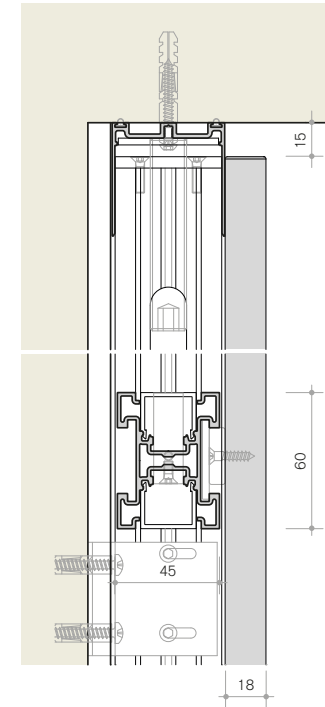

B.
particolare a pavimento
floor detail

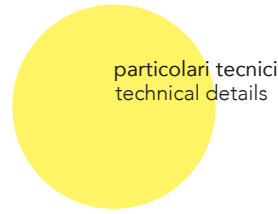
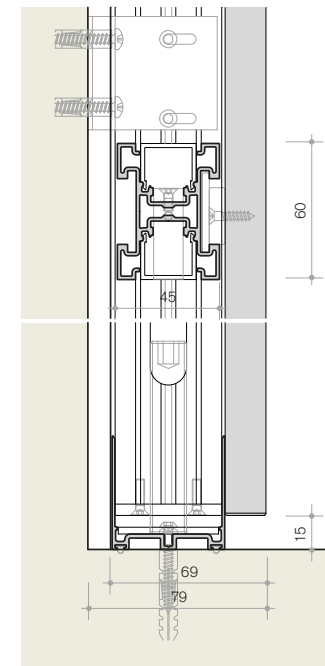

particolari tecnici
technical details

C.
sezione orizzontale
horizontal section

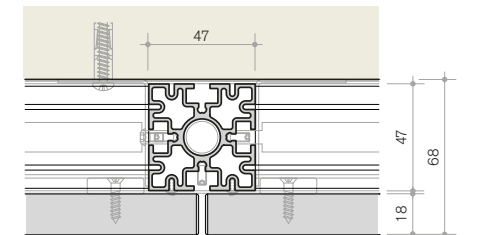

retail





Chameleon combina funzionalità ed estetica per valorizzare al meglio ogni realtà commerciale: i montanti possono essere attrezzati con elementi contenitivi, ripiani ed elementi decorativi. Si personalizza l'estetica senza tralasciare la funzionalità espositiva.

Chameleon seamlessly blends functionality and aesthetic appeal to make every business look its best. The uprights can be equipped with retaining elements, shelves and decorative features, allowing for customisation while maintaining the practicality of the display.

Chameleon allie fonctionnalité et esthétique pour valoriser au mieux n'importe quelle réalité commerciale : les montants peuvent être équipés d'éléments de rangement, d'étagères et d'éléments décoratifs, en personnalisant l'esthétique sans négliger la fonctionnalité de l'affichage.

Chameleon vereint Zweckmäßigkeit und Ästhetik, um das Beste aus jedem Geschäft herauszuholen: Die Ständer können mit Aufbewahrungselementen, Regalen und dekorativen Elementen ausgestattet werden, wodurch die Ästhetik personalisiert wird, ohne den Ausstellungszweck zu vernachlässigen.

Chameleon combina funcionalidad y estética para valorizar cada realidad comercial: los montantes pueden equiparse con elementos de almacenamiento, estantes y elementos decorativos, personalizando la estética sin descuidar la funcionalidad expositiva.



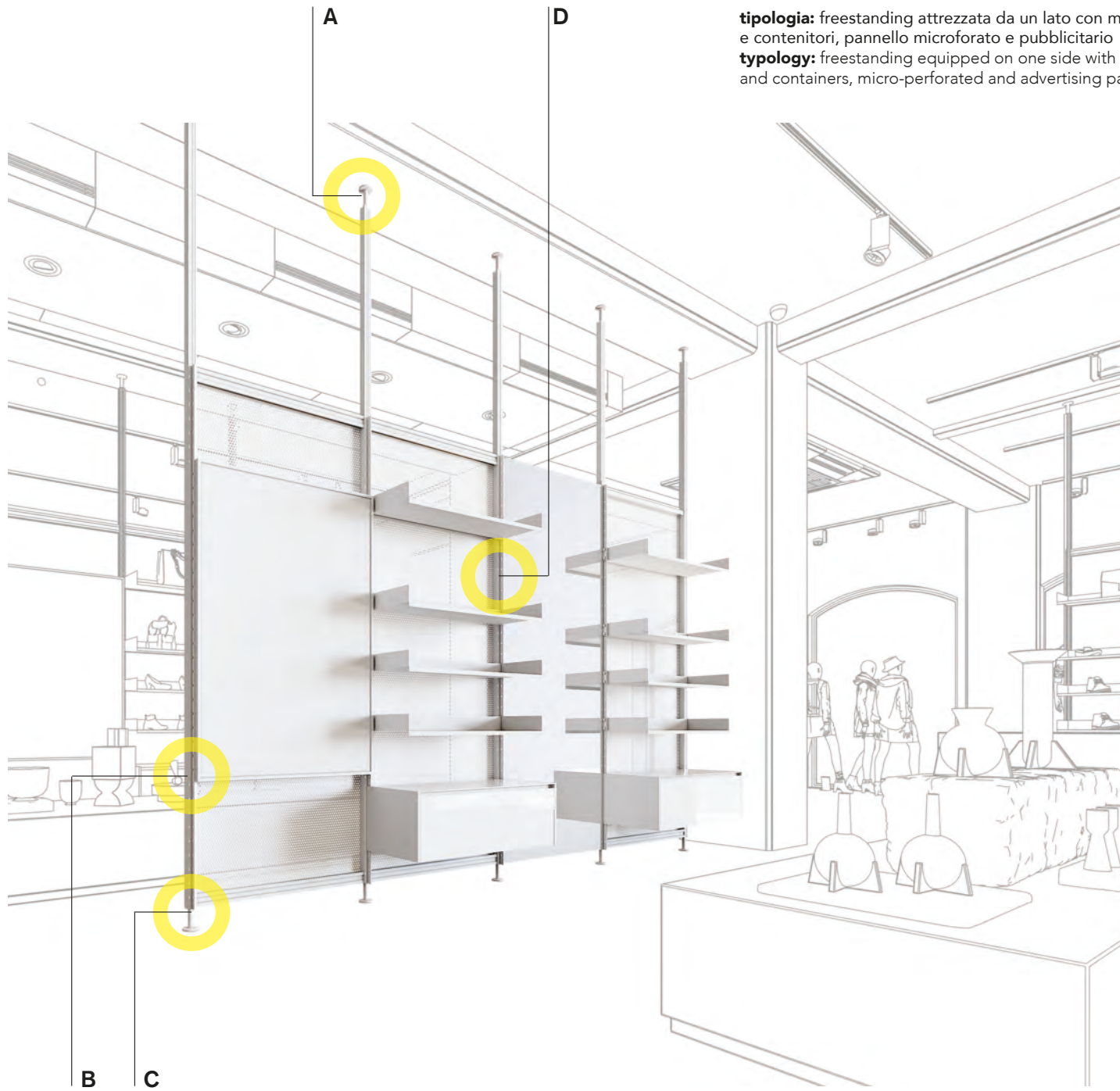

tipologia: freestanding attrezzata da un lato con mensole e contenitori, pannello microforato e pubblicitario
typology: freestanding equipped on one side with shelves and containers, micro-perforated and advertising panels

A. particolare a soffitto ceiling detail

B. particolare pannelli panels detail

C. particolare a pavimento floor detail

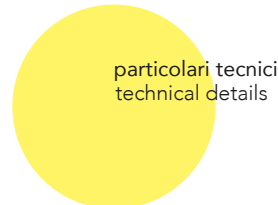
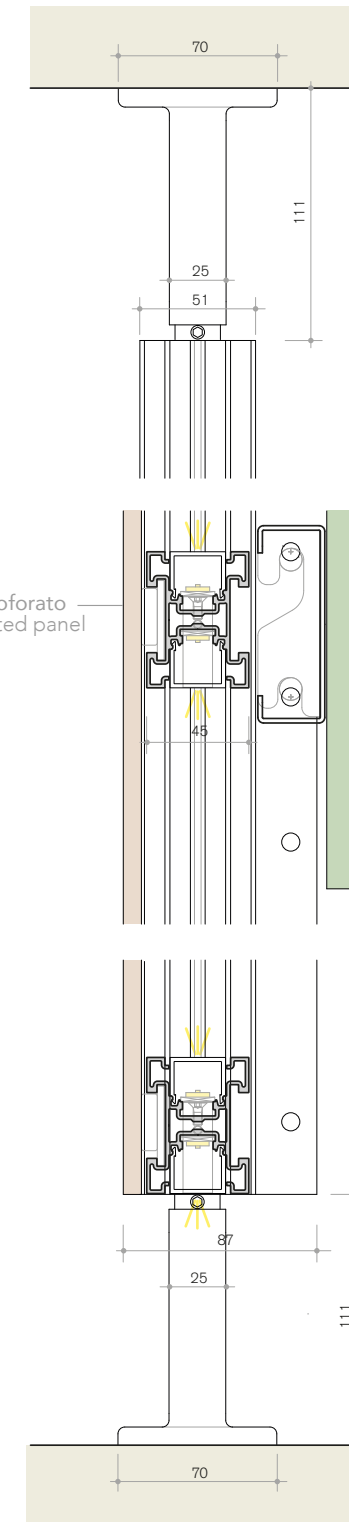

D. sezione orizzontale horizontal section

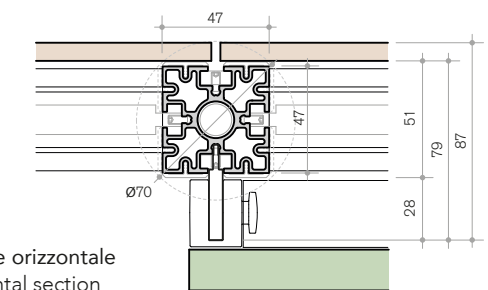



hotel



Chameleon permette di rinnovare camere e spazi comuni senza eseguire importanti lavori edili e impiantistici. L'utilizzo di pannelli decorativi con un'ampia gamma di texture e colori, la possibilità di completare le camere con scrittoi, ripiani e vani chiusi e la semplicità di modificare e sostituire rivestimenti e accessori rappresentano il punto di forza del sistema e un'ottima occasione per rinnovare gli spazi.

Chameleon can give rooms and common areas a new look without the hassle of extensive construction works and system installations. The decorative panels available in a wide array of textures and colours, the option to furnish rooms with desks, shelving and storage compartments, and the ease of changing and replacing coverings and accessories, represent the system's key strength and an excellent opportunity to refresh the space.

Chameleon permet de rénover les chambres et les espaces communs sans la réalisation d'importants travaux de construction et d'installation. L'utilisation de panneaux décoratifs avec une large gamme de textures et de couleurs, la possibilité de compléter les pièces avec des bureaux, des étagères et des compartiments fermés, la simplicité de modification et de remplacement des revêtements et des accessoires, représentent l'un des gros avantages du système et une excellente opportunité de rénover les espaces.

Mit Chameleon können Sie Räume und Gemeinschaftsbereiche ohne große bau- und anlagentechnische Maßnahmen renovieren. Die Verwendung von dekorativen Paneelen mit einer breiten Palette an Texturen und Farben, die Möglichkeit, die Räume mit Schreibtischen, Regalen und geschlossenen Fächern zu vervollständigen, und die einfache Änderung und Ersetzung von Bezügen und Zubehör stellen die Stärke des Systems dar und bieten eine hervorragende Gelegenheit Räume zu renovieren.

Chameleon permite renovar habitaciones y espacios comunes sin necesidad de grandes obras e instalaciones. El uso de paneles decorativos con una amplia gama de texturas y colores, la posibilidad de completar las estancias con escritorios, estanterías y compartimentos cerrados, y la simplicidad para modificar y sustituir revestimientos y accesorios, representan los puntos fuertes del sistema y una excelente oportunidad para renovar los espacios.

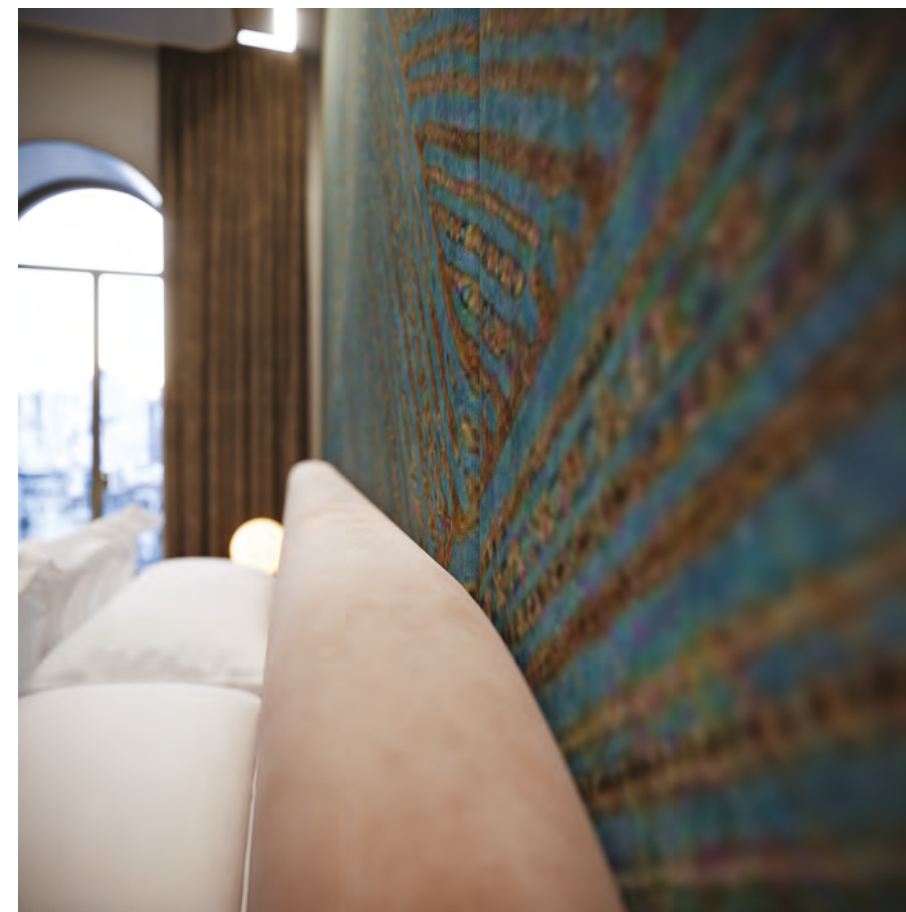



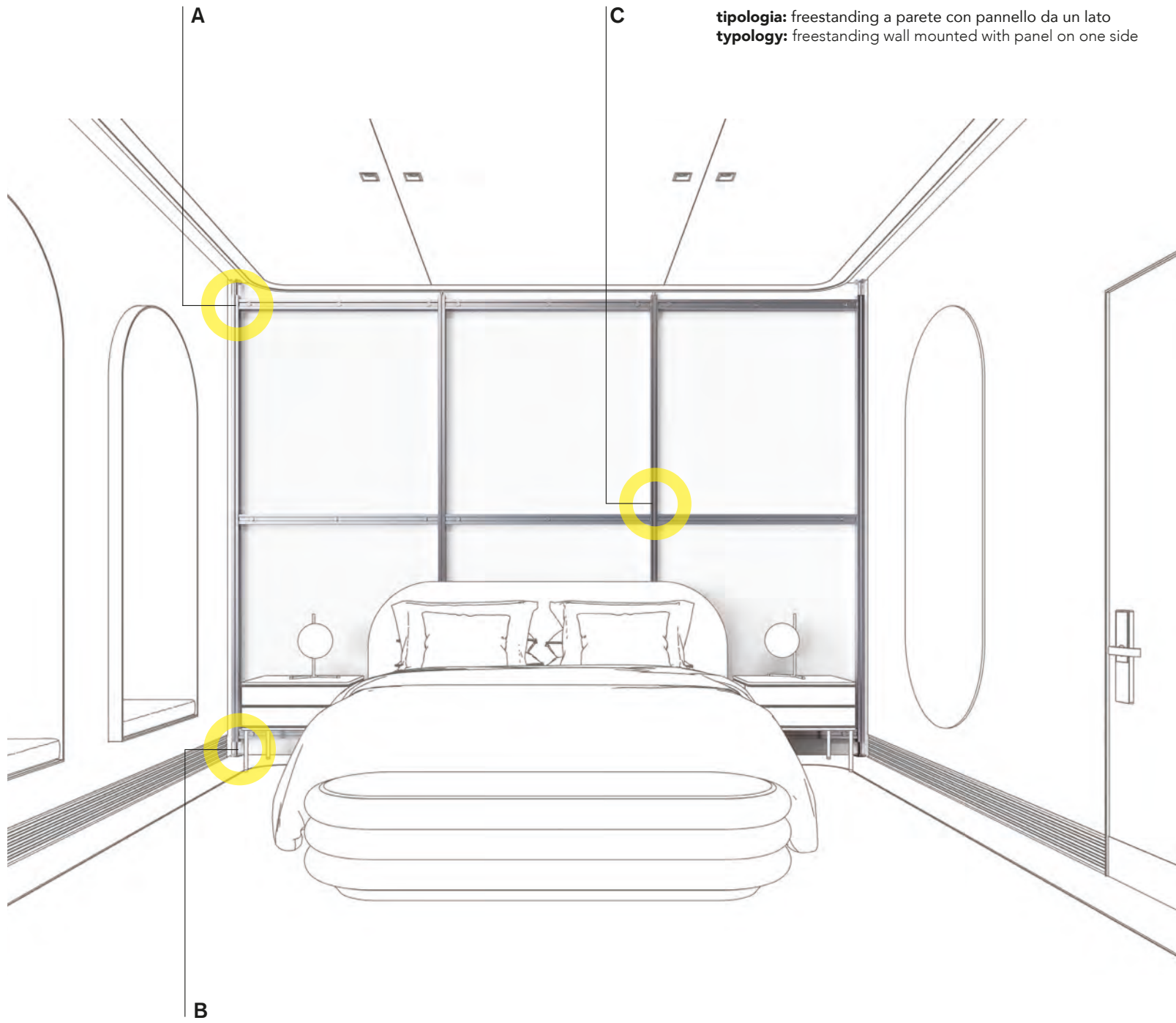

A.
particolare a soffitto
ceiling detail

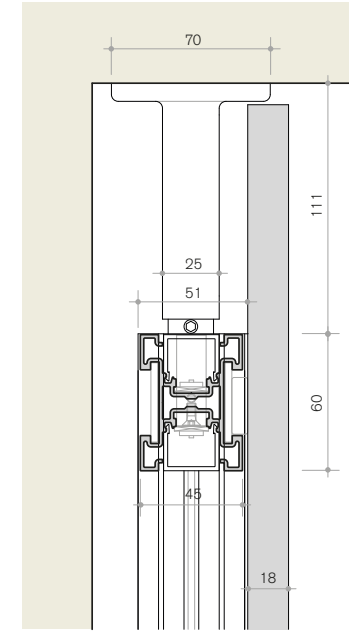

B.
particolare a pavimento
floor detail

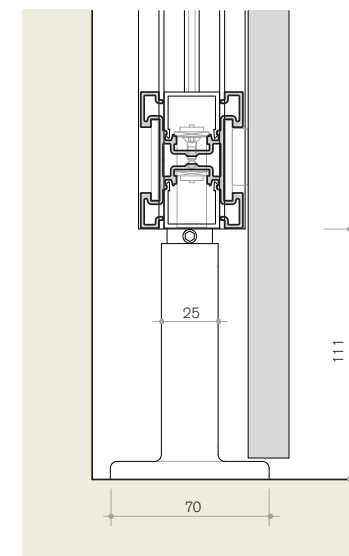
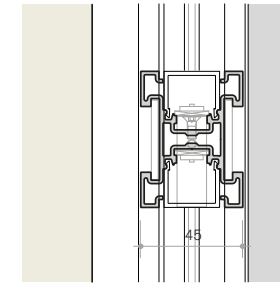

C.
sezione orizzontale
horizontal section

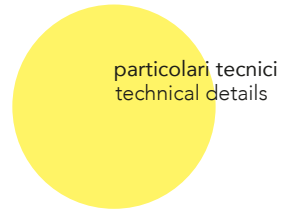
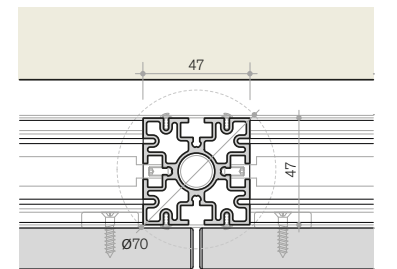

tipologia: a parete, attrezzata con mensole e contenitori, pannello da un lato
typology: wall mounted, equipped with shelves and containers, panel on one side



B - D

A

C

A. particolare a soffitto
ceiling detail

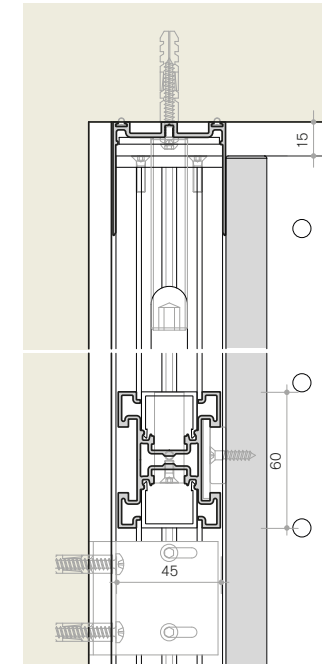

B. particolare aggancio mensola
shelf hooking detail

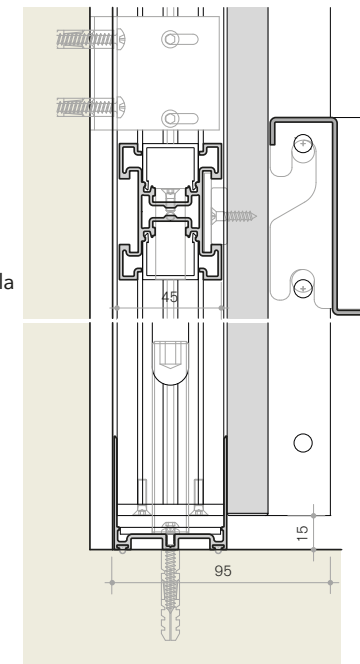

C. particolare a pavimento
floor detail

D. sezione orizzontale
horizontal section

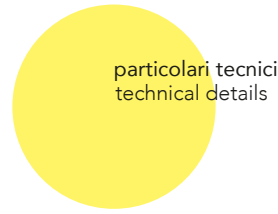
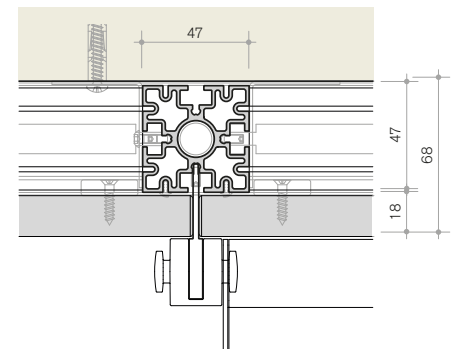

home





Chameleon permette di dividere ed attrezzare con un'immagine moderna. Un divisorio tra cucina e soggiorno in un grande open space. Si può giocare con porzioni trasparenti e cieche, dando un carattere unico a tutto lo spazio.

Chameleon allows modern divisions and fit-outs. A partition between the kitchen and living area in a large open space, playing on transparent and solid portions to infuse the space with unique character.

Chameleon permet de diviser et d'équiper de façon moderne. Une cloison entre la cuisine et le salon dans un grand espace ouvert, en jouant avec des parties transparentes et aveugles pour donner un caractère unique à l'ensemble de l'espace.

Chameleon ermöglicht es, auf moderne Weise zu teilen und auszustatten. Eine Trennwand zwischen Küche und Wohnzimmer in einem großen offenen Raum, die mit transparenten und blinden Teilen spielt und dem gesamten Raum einen einzigartigen Charakter verleiht.

Chameleon permite dividir y equipar de forma moderna. Una división entre cocina y salón en un gran espacio abierto, jugando con porciones transparentes y ciegas, dando un carácter único a todo el espacio.



tipologia: freestanding attrezzata da un lato con mensole, pannello in vetro e decorato
typology: freestanding equipped on one side with shelves, glass and graphic panel

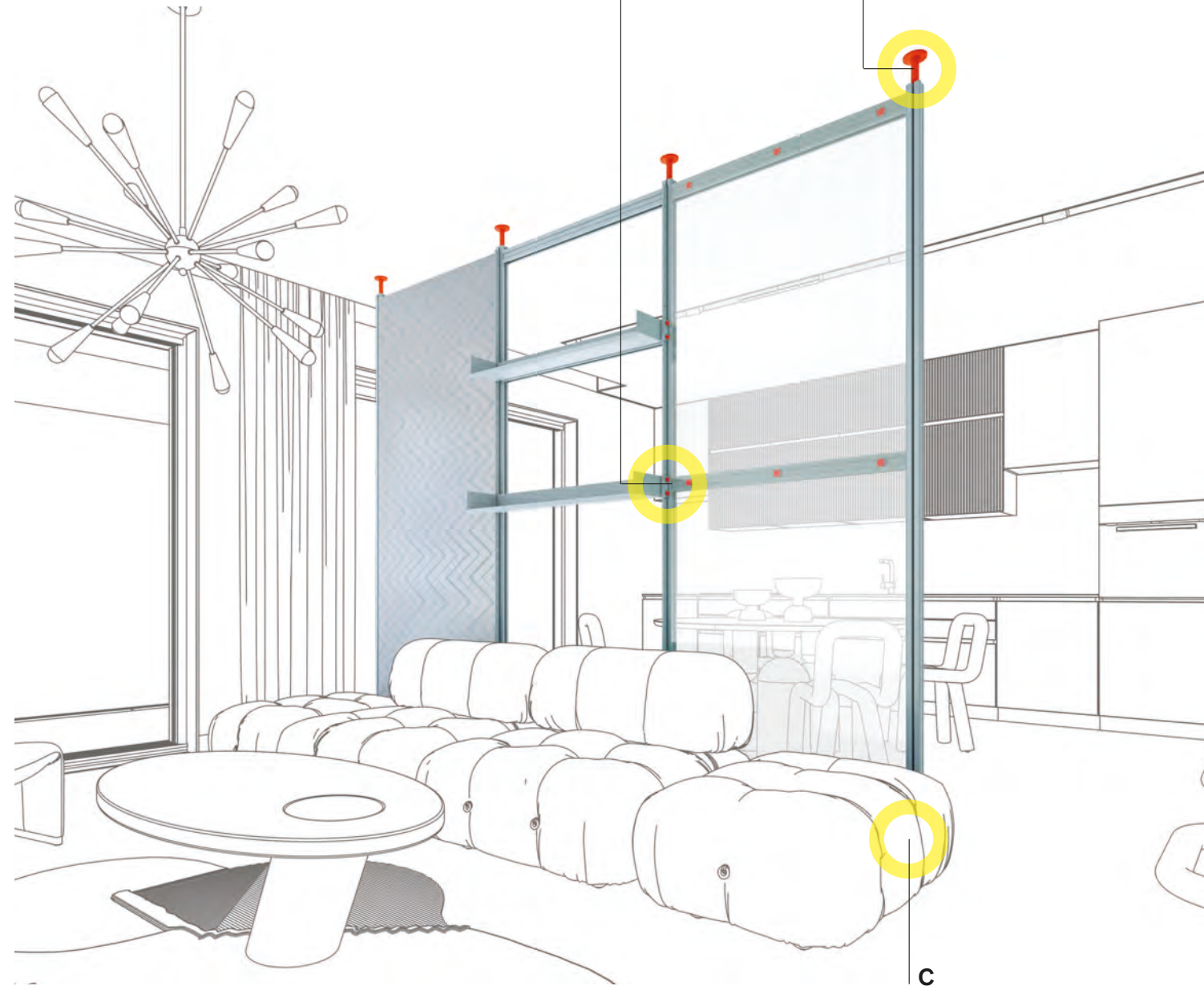

A. particolare a soffitto
ceiling detail

B. particolare aggancio mensola
shelf hooking detail

C. particolare a pavimento
floor detail

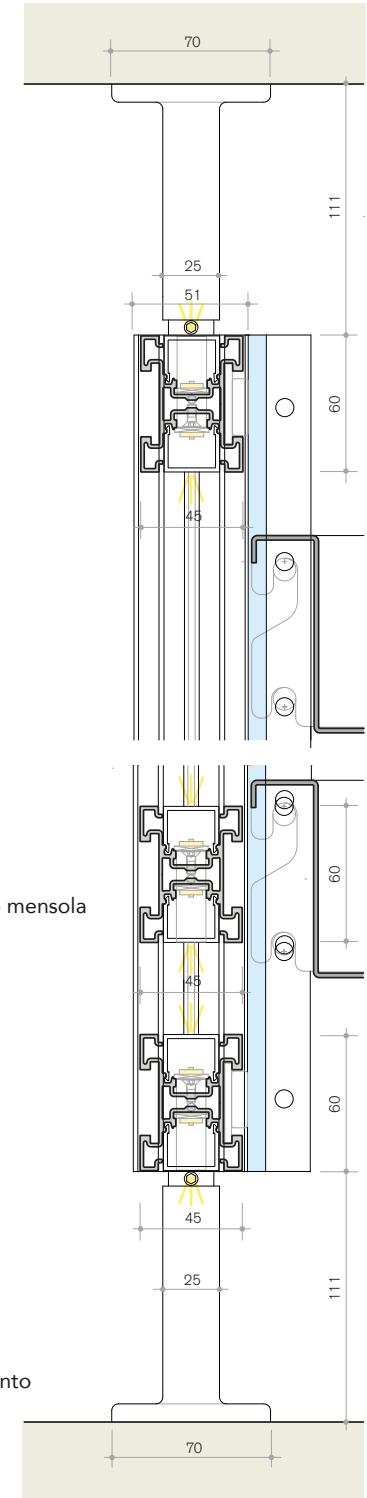

particolari tecnici
technical details

D. sezione orizzontale
horizontal section

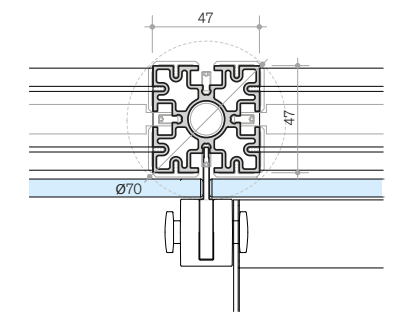



office



Chameleon rappresenta l'opportunità di dividere, attrezzare e personalizzare gli ambienti. Gli elementi divisorii sono stati integrati con il sistema GIANO per creare pareti attrezzate e funzionali; per creare quiet-room sia aperte che chiuse o per installare una grande white-board per la sala riunioni.

Chameleon presents an opportunity to divide, furnish and personalise spaces. The dividing elements are seamlessly integrated with the GIANO system to create equipped and functional walls, establishing open or closed quiet rooms along with a large whiteboard for use in the boardroom.

Chameleon offre la possibilità di diviser, d'équiper et de personnaliser les espaces. Les éléments de séparation ont été intégrés au système GIANO pour créer des cloisons équipées et fonctionnelles, pour créer des espaces ouverts et fermés et même un grand tableau blanc à utiliser pour la salle de réunion.

Chameleon bietet die Möglichkeit, Umgebungen aufzuteilen, auszustatten und individuell zu gestalten. Die Trennelemente wurden in das GIANO-System integriert, um ausgestattete und funktionale Wände zu schaffen und um sowohl offene als auch geschlossene Ruheräume zu schaffen, sogar ein großes Whiteboard für den Besprechungsraum.

Chameleon representa la oportunidad de dividir, equipar y personalizar ambientes. Los elementos divisorios se han integrado con el sistema GIANO para crear paredes equipadas y funcionales, para crear quiet-rooms tanto abiertas como cerradas, incluso una gran pizarra blanca para la sala de reuniones.



tipologia: a parete, attrezzata con piano lavoro, pannello da un lato
typology: wall mounted, equipped with desk, panel on one side

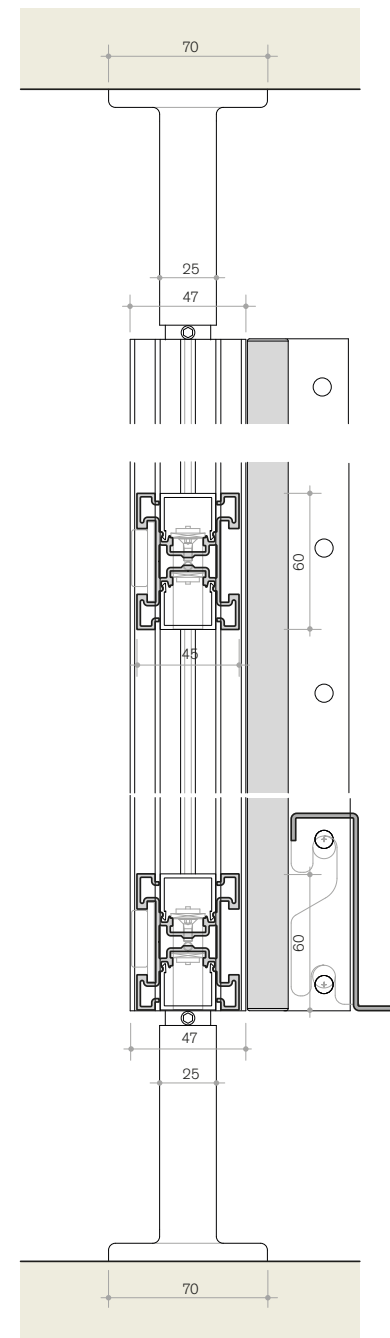
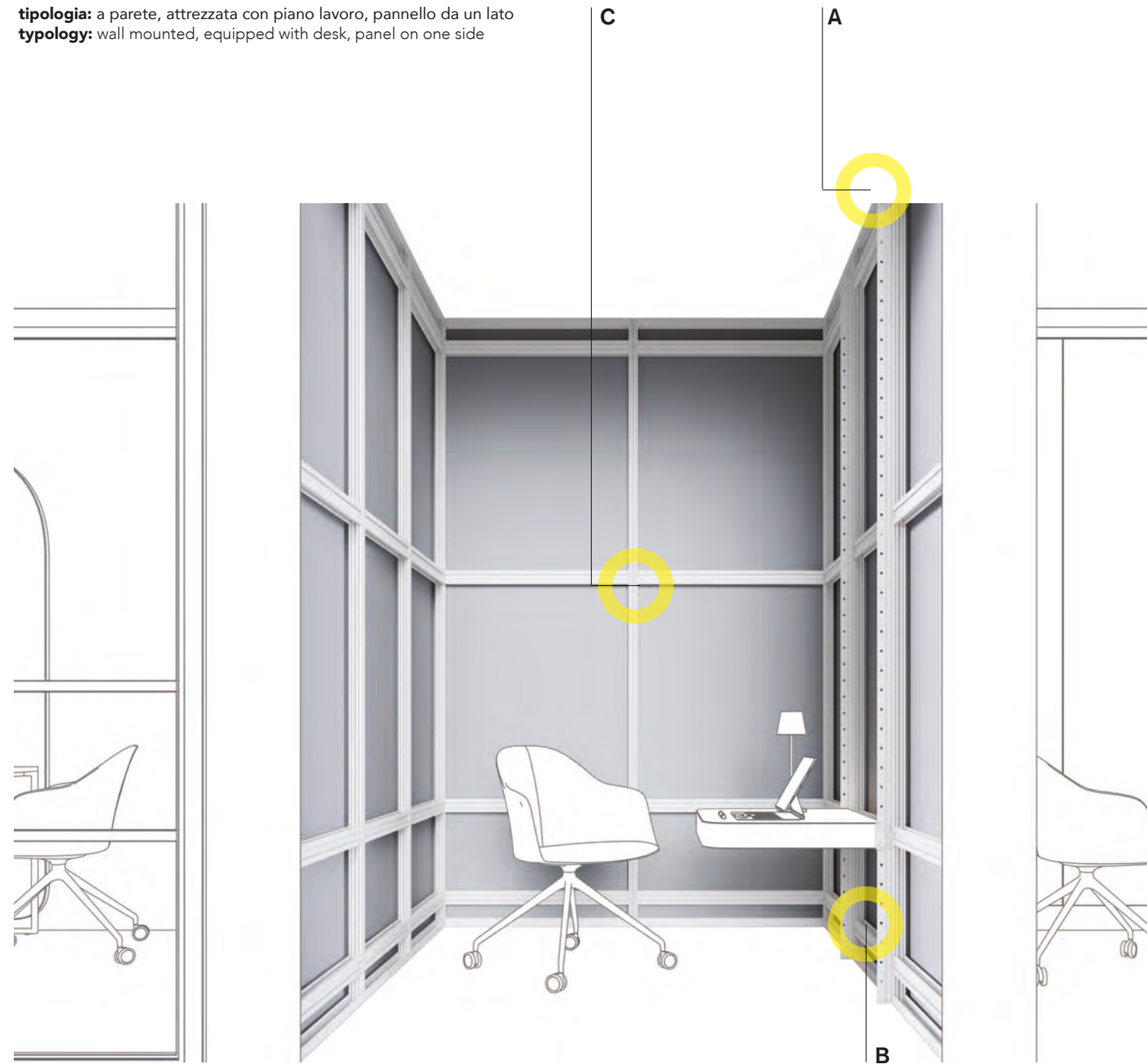

A.
particolare a soffitto
ceiling detail

B.
particolare a pavimento
floor detail

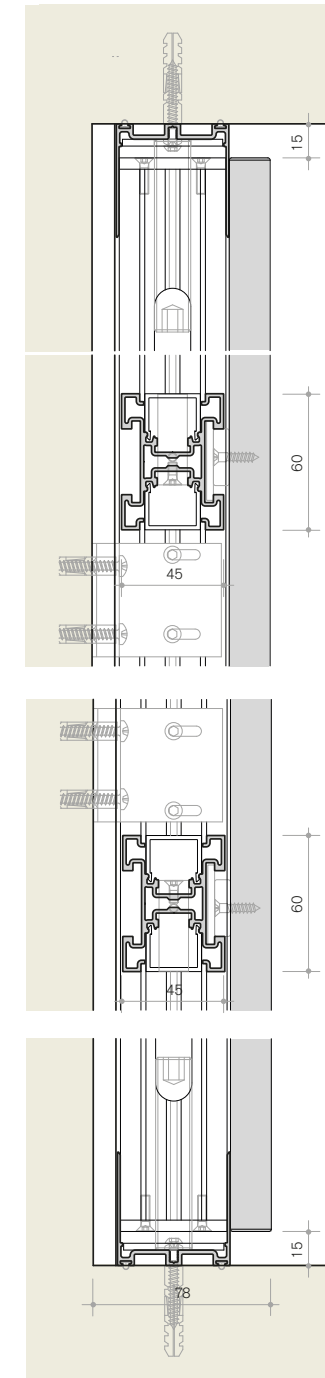

particolari tecnici
technical details

C.
sezione orizzontale
horizontal section

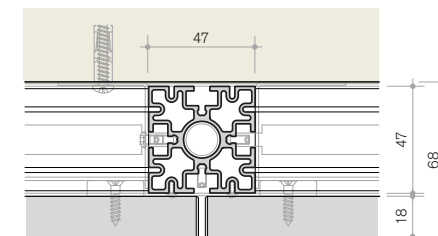

art gallery



AS A PORTRAIT PHOTOGRAPHER
'DUCE, AMUSE AND ENTERTAIN.'

HELMUT NEWTON



VICTOR CHIJOKE



VICTOR CHIJOKE
UNTITLED 2023



VICTOR CHIJOKE



VICTOR CHIJOKE
UNTITLED 2023



Con Chameleon è possibile creare quinte sulle quali esporre. Il sistema è formato da pannelli con struttura a pressione pavimento/soffitto. I pannelli possono essere facilmente rimossi e/o rimodulati secondo le esigenze espositive.

Chameleon can be used to create "backstage" areas using a panel system with a floor-to-ceiling press-fit structure for display purposes. The panels can be easily removed and/or reconfigured to adapt to different display needs.

Avec Chameleon il est possible de créer des toiles de fond au moyen d'un système de panneaux avec une structure de pression sol/plafond sur laquelle il est possible d'exposer. Les panneaux peuvent être facilement enlevés et/ou composés en fonction des besoins de l'exposition.

Mit Chameleon ist es möglich, Kulissen mithilfe eines Paneelsystems mit einer Druckstruktur Boden/Decke zu schaffen, die als Ausstellungsfläche genutzt werden können. Die Paneele können je nach Ausstellungsbedarf leicht entfernt und/oder neu zusammengestellt werden.

Con Chameleon es posible crear bastidores mediante un sistema de paneles con estructura a presión sobre el suelo/techo sobre los que exponer. Los paneles pueden desmontarse y/o remodelarse fácilmente en función de las necesidades de exposición.



tipologia: freestanding con pannello su due lati
typology: freestanding with panel on both sides

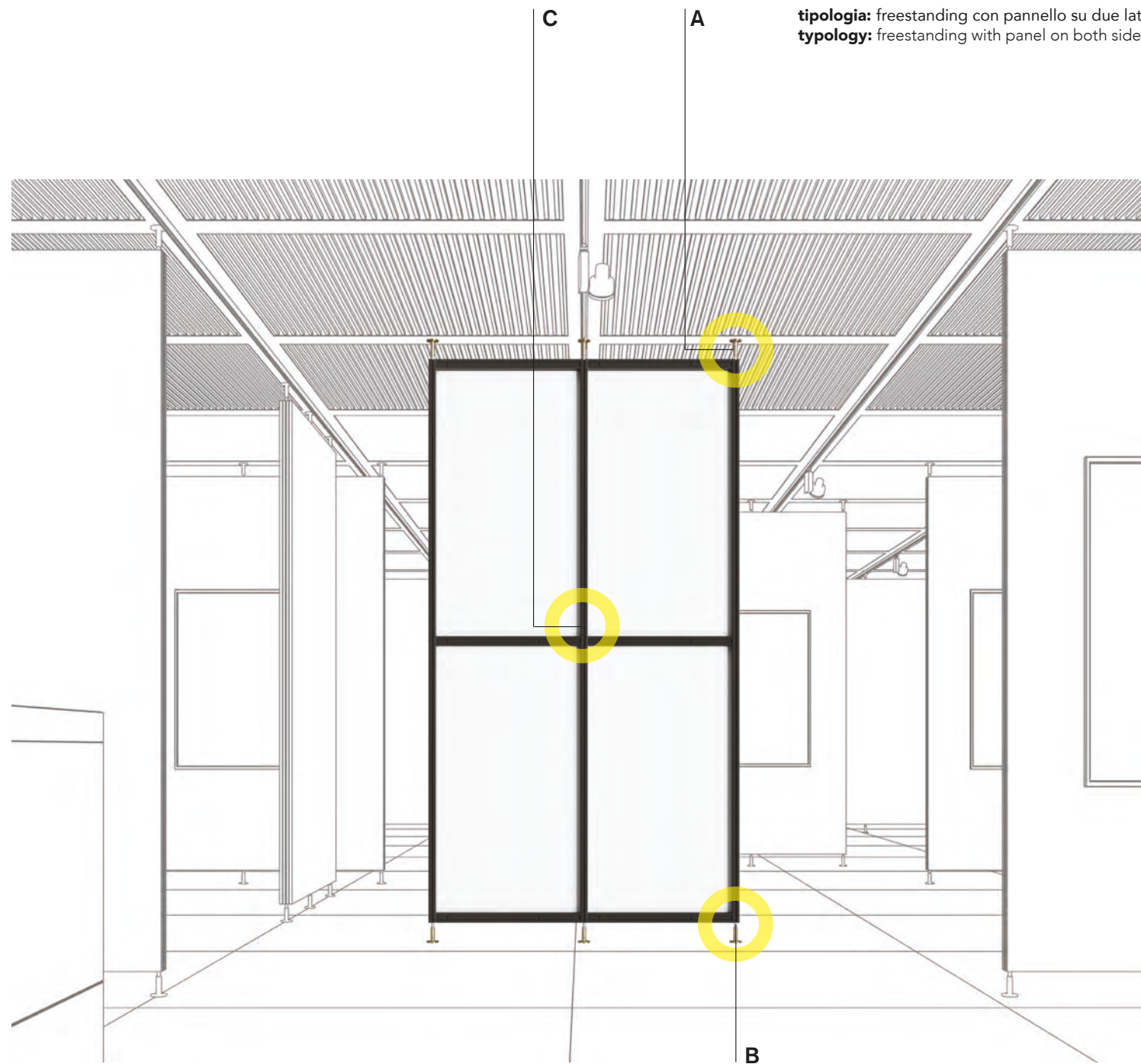

particolari tecnici
 technical details

A.
 particolare a soffitto
 ceiling detail

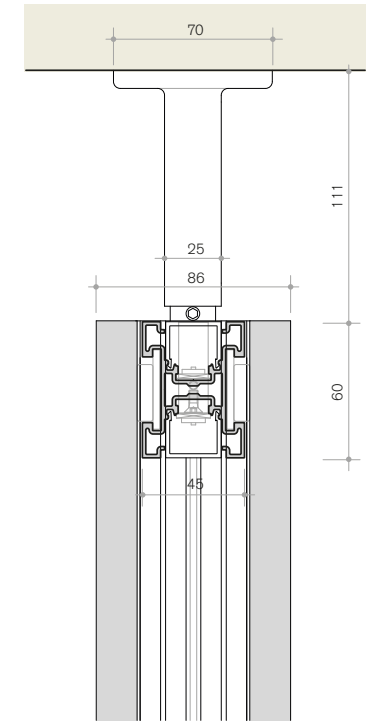

B.
 particolare a pavimento
 floor detail

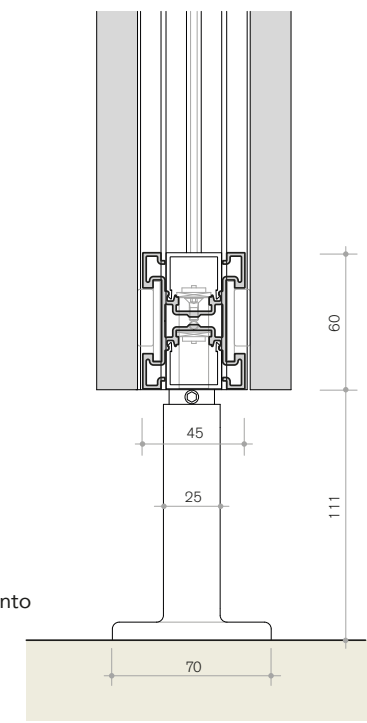

C.
 sezione orizzontale
 horizontal section

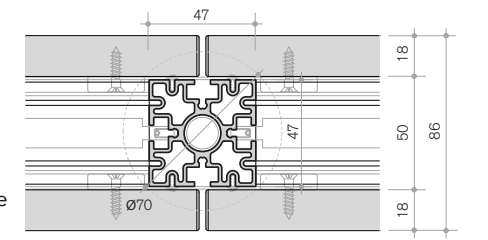

phone booth





Chameleon si trasforma in box chiuso autoportante integrato con il sistema di pareti in cristallo SIMPLE. Questi spazi dedicati alla maggior concentrazione ed isolamento dall'open space possono essere realizzati con o senza il celino e dotati di consolle.

Chameleon transforms into a closed, self-supporting box integrated with the SIMPLE glass wall system. These spaces designed to improve concentration and isolation from the open space can be developed with or without a ceiling panel and equipped with consoles.

Chameleon se transforme en un box fermé autoportant intégré au système de parois vitrées SIMPLE. Ces espaces, dédiés à une plus grande concentration et à l'isolation de l'espace ouvert, peuvent être réalisés avec ou sans cabine téléphonique et équipés de consoles.

Chameleon verwandelt sich in eine selbsttragende geschlossene Box, die mit dem SIMPLE-System aus Glaswänden integriert ist. Diese Räume, die einer größeren Konzentration und Isolierung vom offenen Raum dienen, können mit oder ohne Blende realisiert und mit Konsolen ausgestattet werden.

Chameleon se transforma en un box cerrado autoportante integrado en el sistema SIMPLE de paredes de cristal. Estos espacios, dedicados a una mayor concentración y aislamiento del espacio abierto, pueden realizarse con o sin techo y equiparse con consolas.



tipologia: box chiuso autoportante
typology: freestanding box

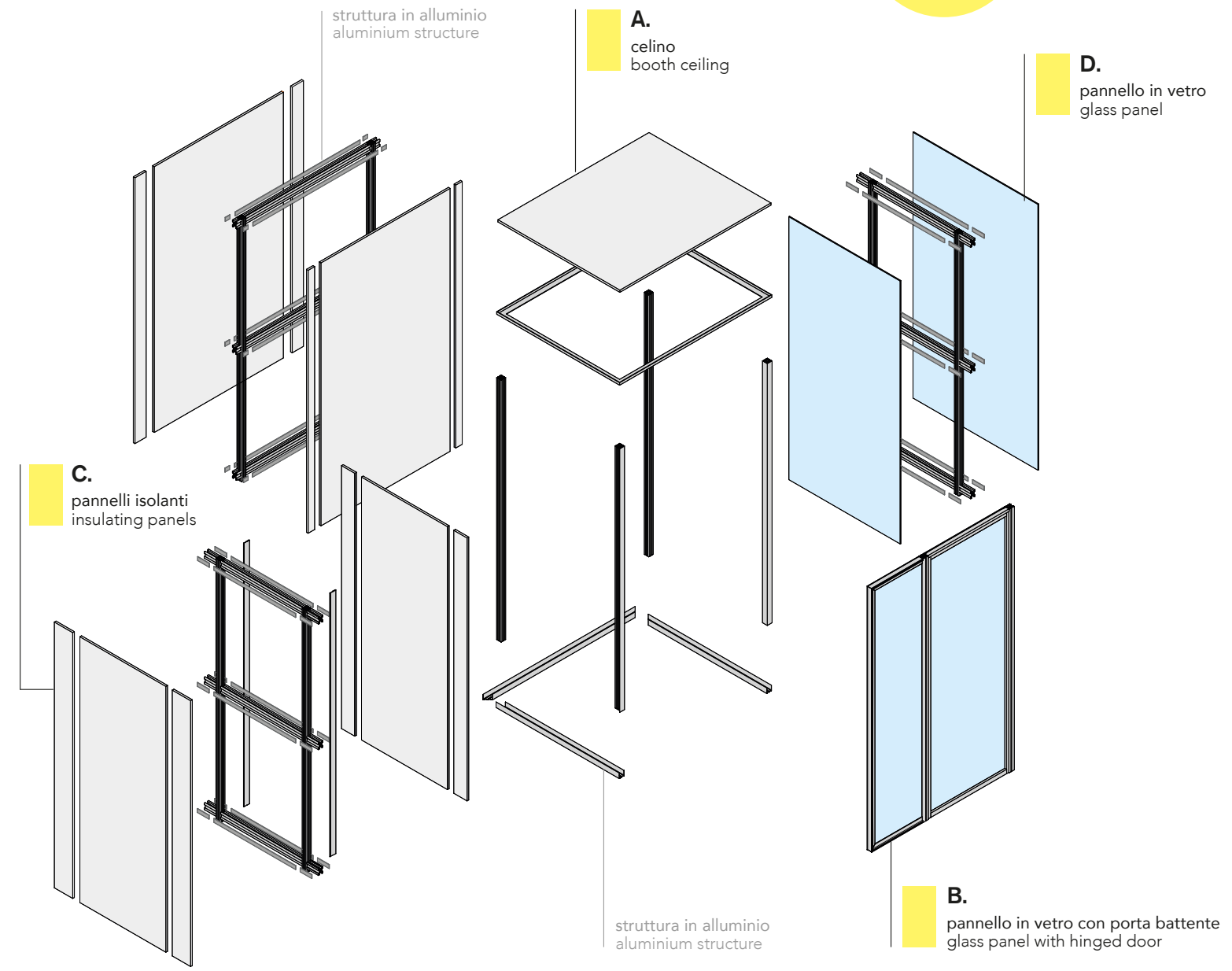
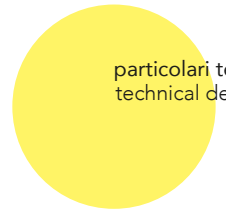
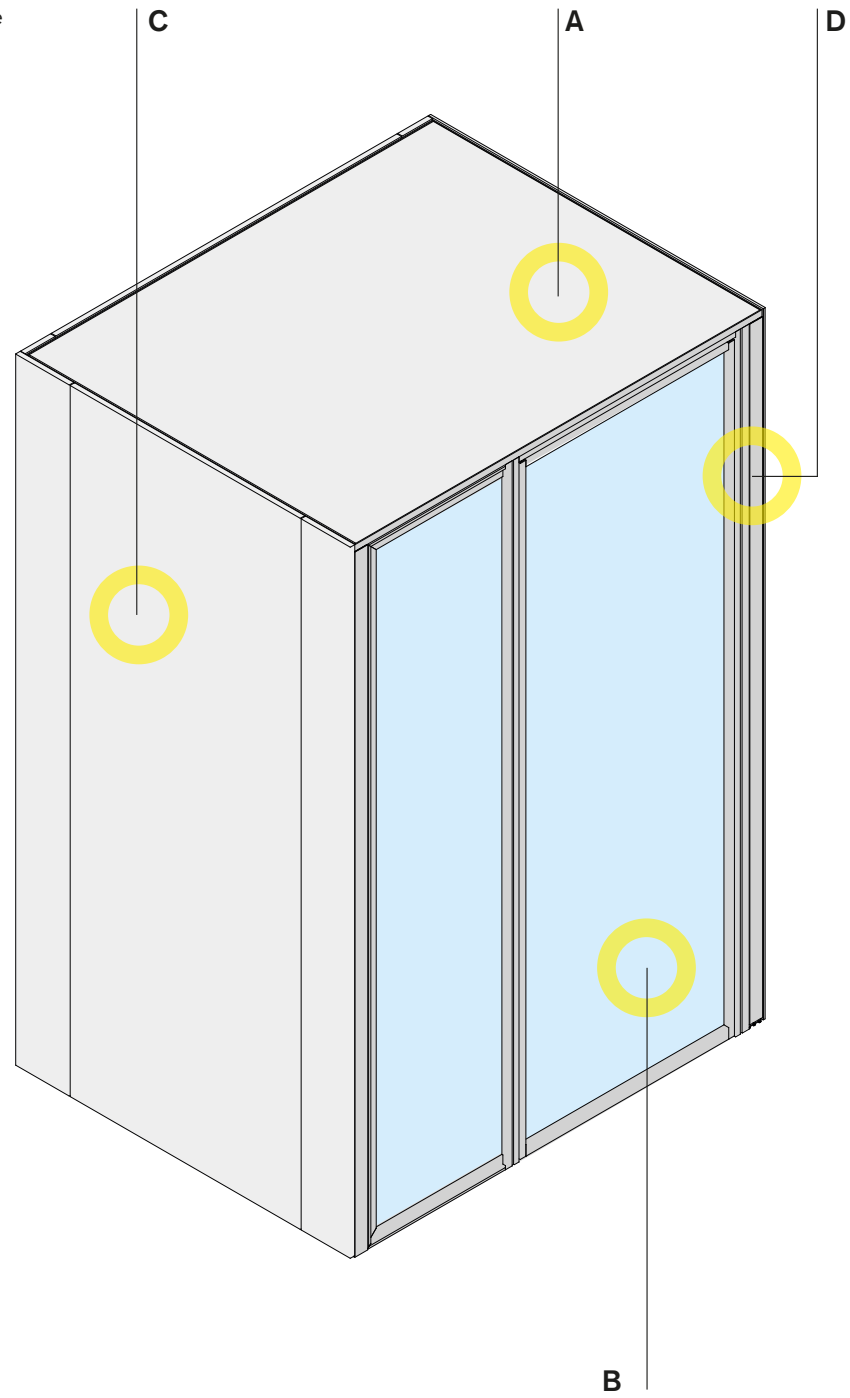

product design
Il Prisma e Danilo Premoli

engineering
Iaco Design Studio

visual 3D
Echoo Studio

copy
Luconi & C. srl

made and printed in Italy by
Compograf srl

© Luconi 2024